

TecnoRampa™



Vehicle Restraint

tecnorampa.us

User Manual



DOCK SAFETY SYSTEM ›

VEHICLE RESTRAINT

TECNORAMPA.

This device is designed to ensure that trucks remain stationary during loading and unloading operations at loading docks. This system is essential for the safety of both the personnel and equipment involved in the process.



OPERATION SYSTEM ›

› HYDRAULIC

› ELECTRIC



› WE OFFER

VARIOUS FINISHES

Powder Coating



Galvanized

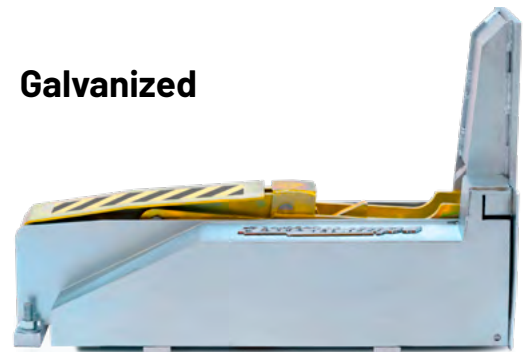

FEATURES ›



● Restraint



Visual and Audible Indicators



Compatibility with Different Types of Vehicles



Durability and Strength



Resistance (IP64)



Easy Maintenance



Integration with Dock Safety Systems



Automation and Remote Control

PRIMARY FUNCTION ›



PROTECTION

of the personnel:

Keeps the truck stationary, protecting workers.



ACCIDENT

prevention:

This system ensures that trucks do not move.



REDUCES

Materials damage:

Prevents the truck from moving and causing damage to facilities.



32,000 POUNDS

LOAD CAPACITY



This device is designed to ensure that trucks remain stationary during loading and unloading operations at loading docks. This system is essential for the safety of both personnel and the equipment involved in the process.

COMPONENTS



LINEAR ACTUATOR

IP 69k with LED pilot light

PROXIMITY SENSORS

Brass with bronze coating

CONTROL PANEL

Solid-state programmable logic controller (PLC), panel, and components with UL and UL-C certification

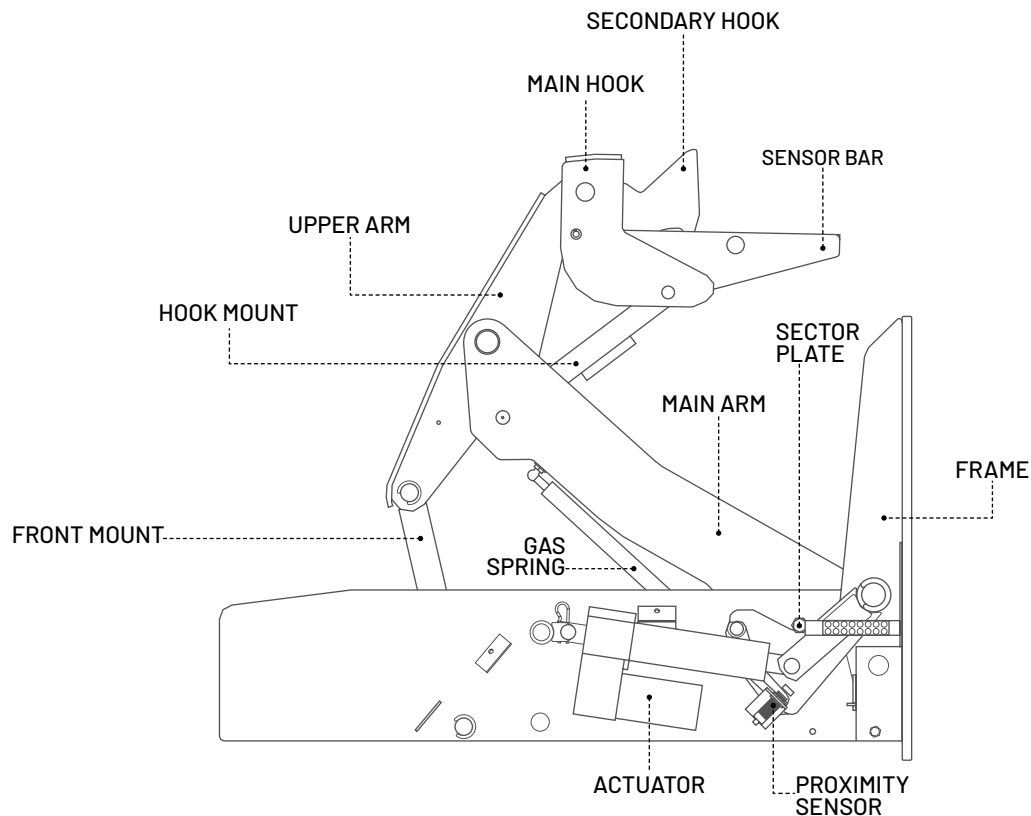

INSTALLATION ›



The standard bolts included with this product are only suitable for its use with solid concrete docks. Docks constructed with other materials require special mounting considerations. Please contact the service department for more information.

Anchor Bolts



CONTROLS

OPTIONAL

We offer control box options that can be customized to your requirements. Install the control box inside the building at 63 inches above the floor, to the left of the door.

Power Supply
110 VAC

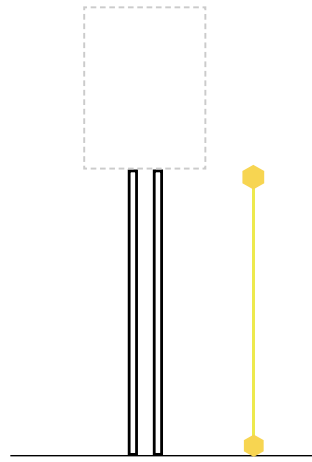

Install the control box inside the building at 63 inches above the floor, to the left of the door.

160 cm

BASIC CONTROL





Designed to control:

-  Restraint
-  Ramp



COMPLETE CONTROL

Designed to control:

-  Restraint
-  Ramp
-  Traffic Light
-  Lamp
-  Fan



PRODUCTS ›

COMPLEMENT YOUR DOCK LINE

Our line of loading dock levelers and platforms has been developed to meet all the industry's requirements for safety, durability, and ease of operation. Tecnorampa provides solutions for all types of load handling needs with hydraulic, mechanical, spring-edge, and accessory options, among others. Each Tecnorampa leveler is designed to create a perfect connection between the platform and the cargo carrier to execute loading and unloading operations quickly, safely, and with minimal effort.

› MECHANICAL DOCK LEVELER



Our new mechanical dock leveler is developed for its use in loading and unloading operations at cargo handling points. It is a highly durable ramp that provides absolute reliability in operation, featuring side guards, a safety bar, and automatic locking lips to prevent accidents and facilitate operation.

Operating System: Mechanical
Finish: Slate Gray/Yellow

› HYDRAULIC DOCK LEVELER



Our hydraulic dock leveler is designed to offer multiple solutions for loading and unloading operations of 30,000, 40,000, and up to 50,000 lbs, maintaining perfect leveling between the warehouse and the truck. With this powerful ramp system, logistics operations can be efficiently optimized with just the touch of a button, whether loading or unloading heavy cargo.

Operating System: Hydraulic
Finish: Slate Gray/Yellow

› EDGE DOCK LEVELER



Our innovative Mini Dock product is specially developed to meet needs for timing, installation, and operation. It features a mechanical operation system, requiring no electrical connection, and operates by simply lifting a lever. The Mini Dock has a stable and secure load capacity of up to 30,000 lbs. This product is set to revolutionize daily industry operations with the best technology and the best price.

> VEHICLE RESTRAINT

WE ARE MANUFACTURERS >

EXPLORE OUR
EXPERTISE IN:

TecnoRampa®



PARTS



ATTENTION



SERVICE



GOMSA
Go forward

tecnorampa.us

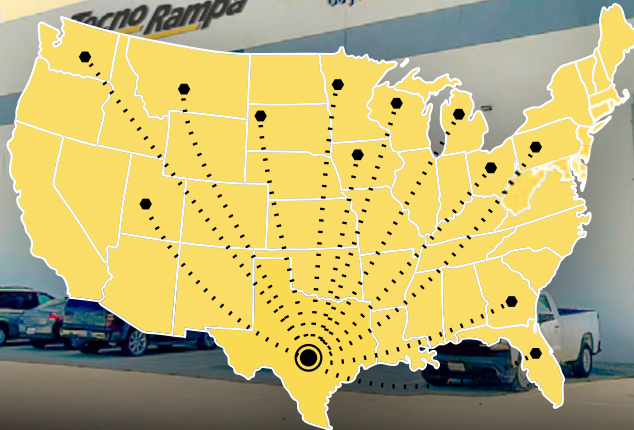

Rhinolifts llc



TecnoRampa



TECNORAMPA S.A. de C.V.

Toll free:
(800) 6230 332
30-Line Telephone
Switchboard (427) 272 8119, (427) 272 4041

1586 N Goldenrod Road, Orlando, Florida

www.tecnorampa.us

